

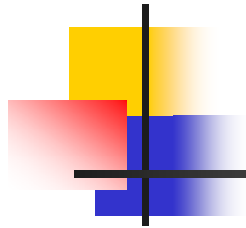

Le cerveau peut jouer des tours

Jérôme Favrod

Lorsque vous présentez les diapositives, mettez Acrobat Reader en mode plein écran avec les touches Ctrl + L.



Que voyez-vous?

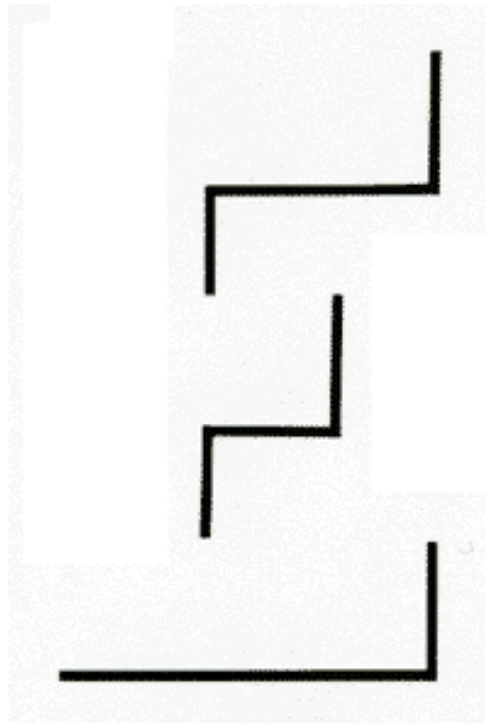



Le cerveau peut vous faire voir des choses qui n'existent pas !

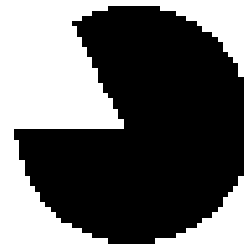
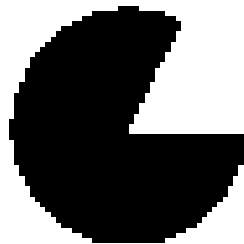
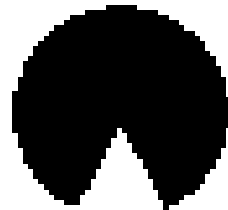

Le cerveau peut voir des formes
qui n'existent pas





Le cerveau peut être trompé

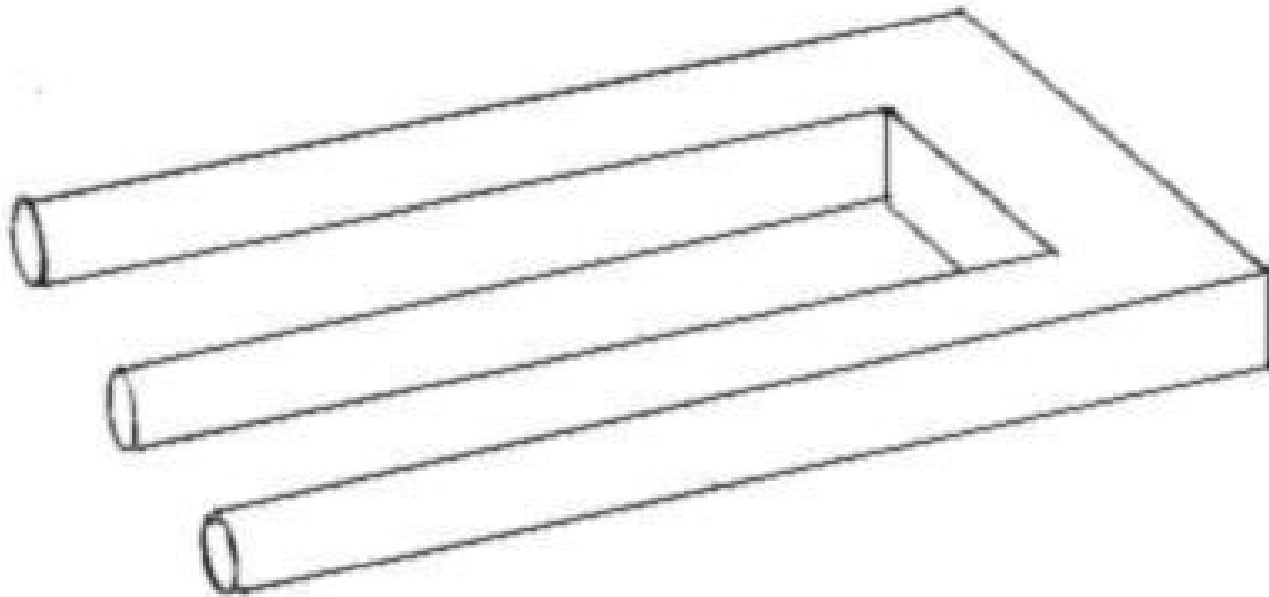

Fixez le point noir et avancez la tête

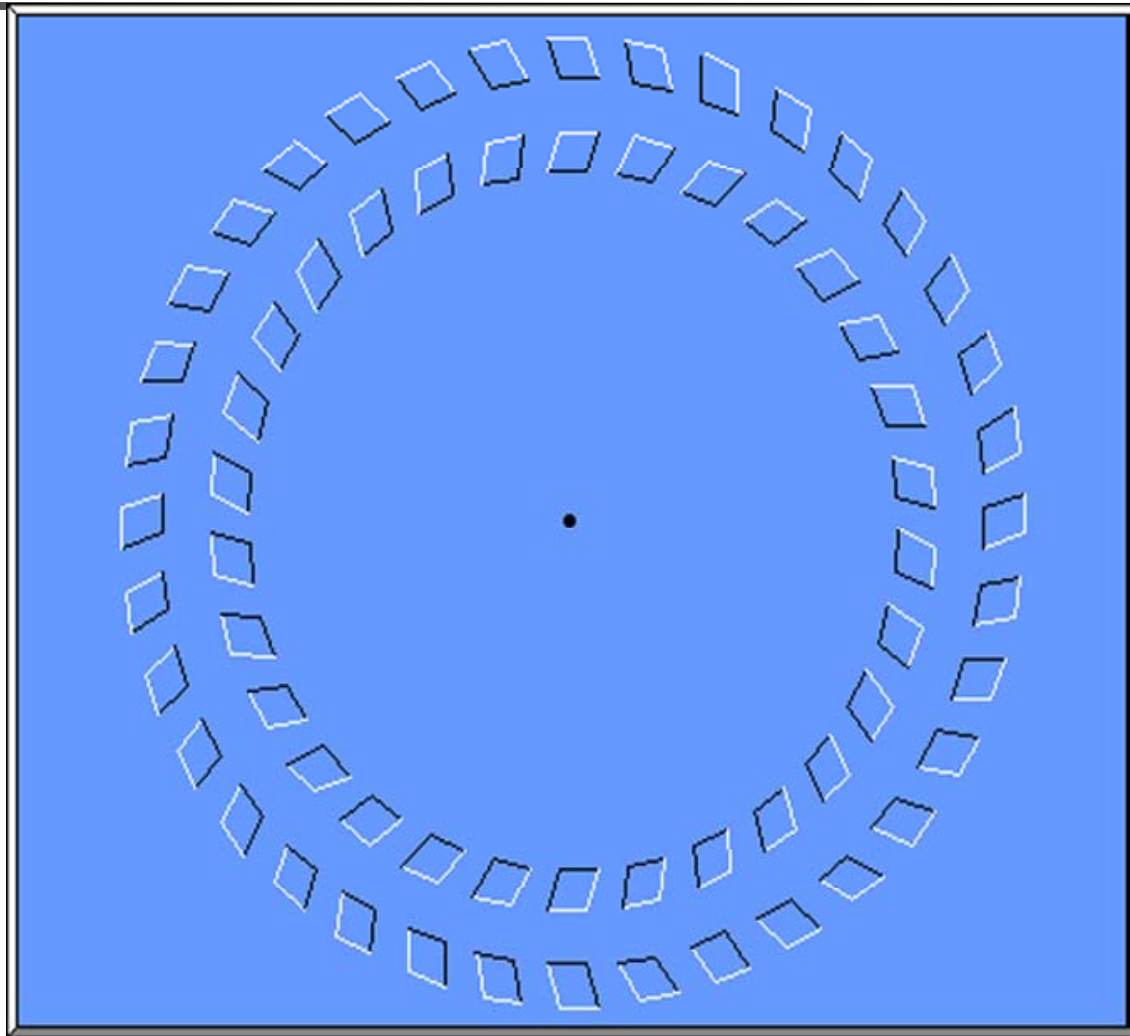



Fixez le rond et faites non de la tête

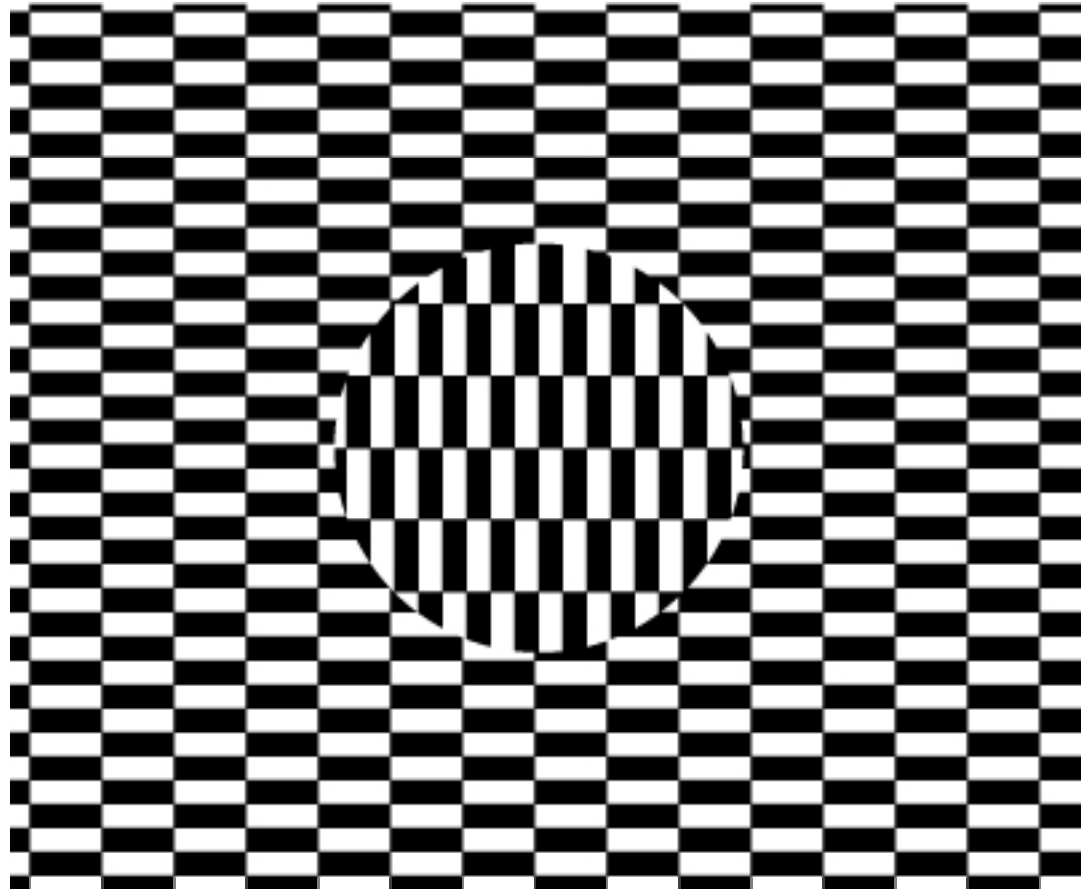



Ces deux traits sont-ils égaux?

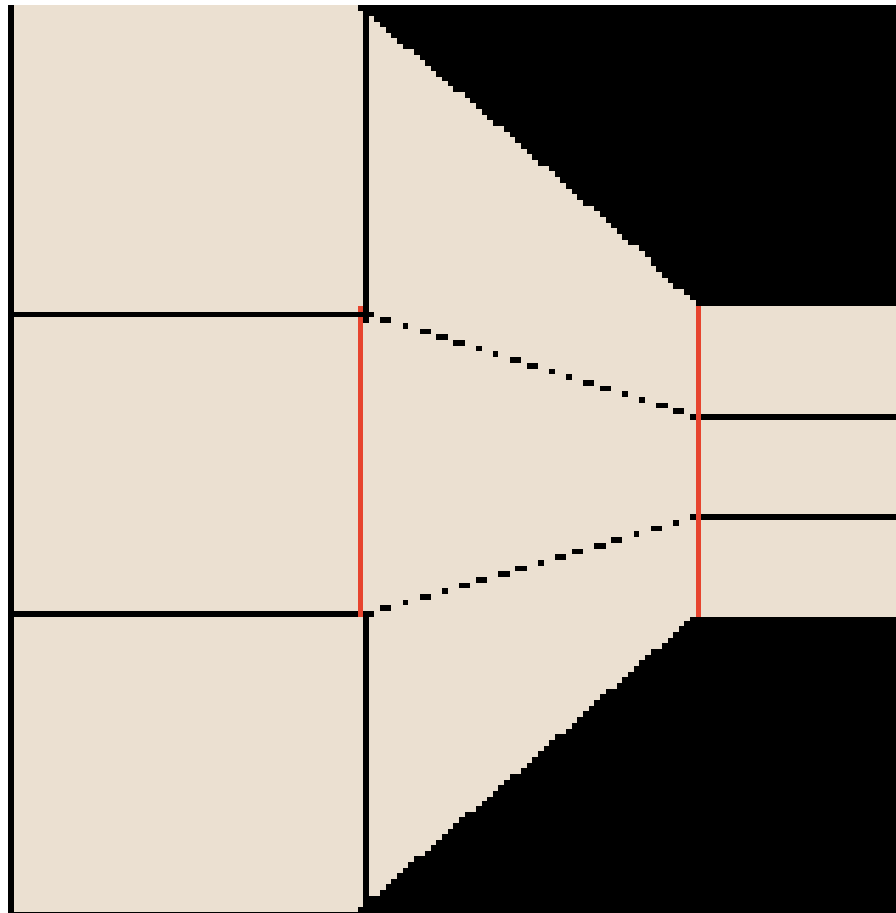



Ces deux traits sont-ils égaux?

